

APENDICE 1. - DEFINIÇÃO DA OCUPACIÓN DEFINITIVA SOBRE PLANO PARCELARIO

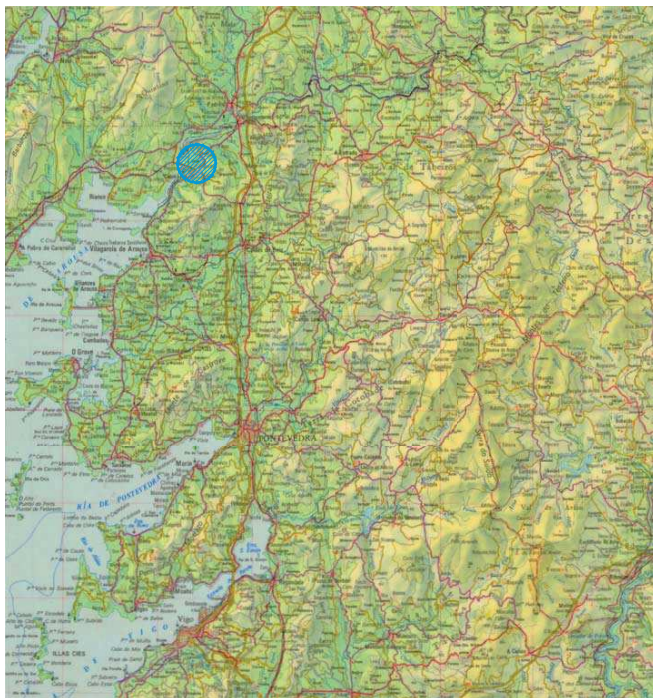

RÍO ULLA

VALGA

TRAZADO ORDE DE ESTUDO

E: 1/10.000

ESCALA: 1:10.000 CONSTRUCCIÓN

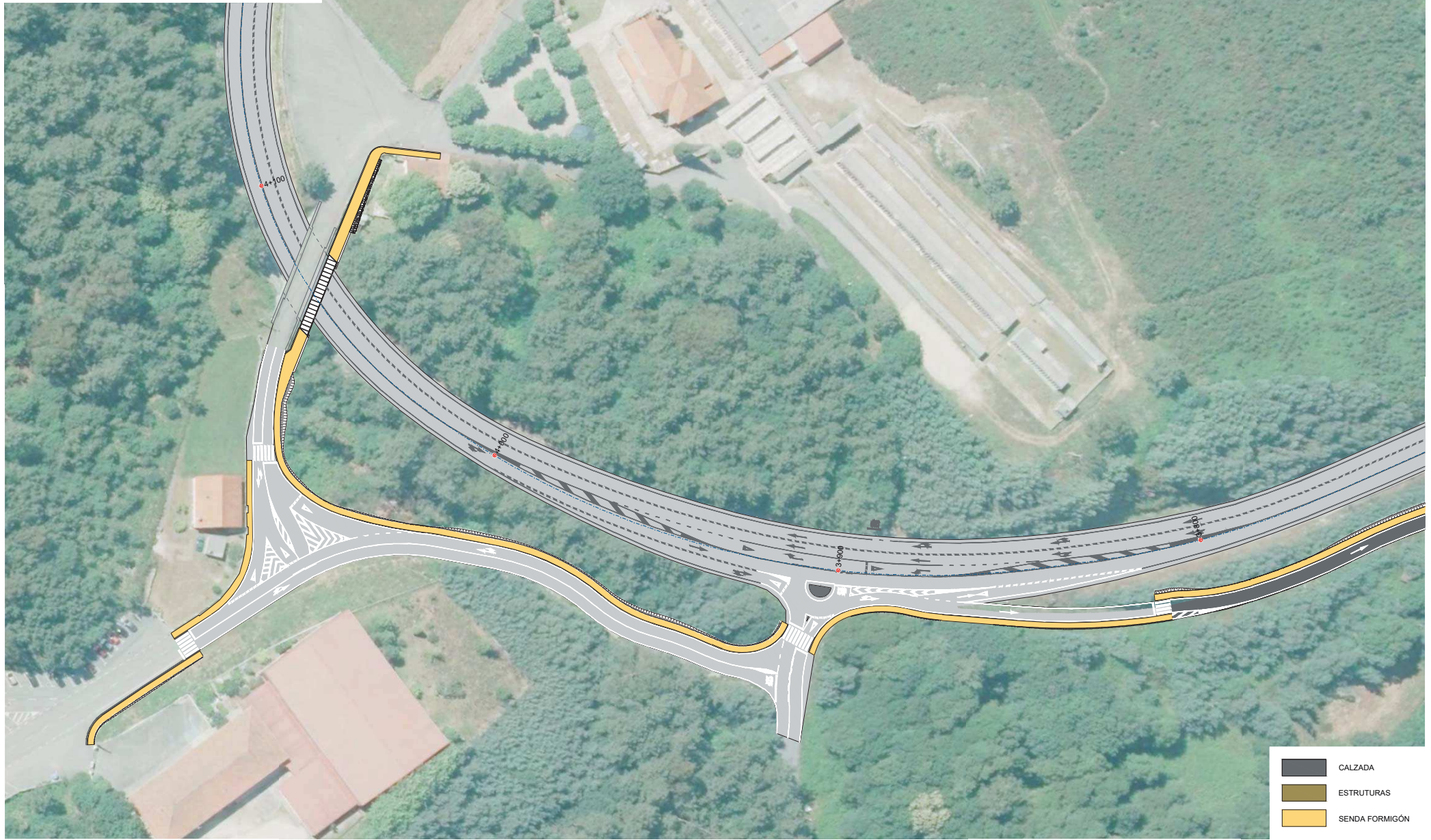
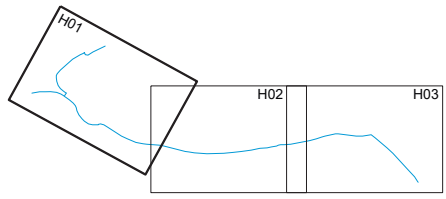

	CALZADA
	ESTRUTURAS
	SENDA FORMIGÓN

ESCALA: 1:1000 - PROJ. CONSTRUCCIÓN

XUNTA DE GALICIA
CONSELLERÍA DE
INFRAESTRUTURAS E MOBILIDADE



CONSULTOR:
CONSTRUCIÓN

OS ENXENHEIROS DE CAMIÑOS, CANLES E PORTOS
AUTORES DO PROXECTO:
SANTIAGO J. PÉREZ VÁZQUEZ IGNACIO TEIXEIRO GALVO

O ENXENHEIRO DE CAMIÑOS,
CANLES E PORTOS
DIRECTOR DO PROXECTO:
CARLOS LEFEBRE GALLÓN

EXAMINADO, A ENXENHEIRA XEFA:
MARÍA SÍDOS TEJADA LÓPEZ

DESBUXADO POR:
LUCÍA GARCÍA MARTÍNEZ

SUBSTITUÍDO POR:
SANTIAGO J. PÉREZ VÁZQUEZ

ESCALAS:
A1=1:500
A3=1:1.000
0 5 10 15 20

TÍTULO:
PROXECTO DE CONSTRUCCIÓN DE SENDA
NA PG-548 (PROG 2+070 - 3+200)
E CONTINUIDADE NUN VIAL MUNICIPAL
NO CONCELLO DE VALS

CLAVE:
PO/19/072.06

NUMERO DE PLANO:
AN18.2
FOLLA:
1 DE 3

DESIGNACIÓN DO PLANO:
EXPROPIACIÓN
PLANTA XERAL SOBRE ORTOFOTO

DATA:
DECEMBRO 2020
NUMERO DE PAXINA:

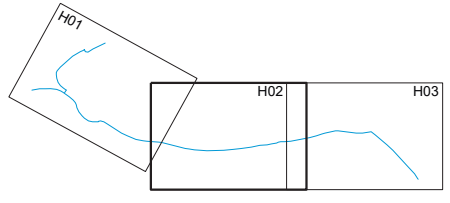

- CALZADA
- ESTRUTURAS
- SENDA FORMIGÓN

ESCALA: 1:1000 CONSTRUCCIÓN

		CONSULTOR:	OS ENXENHEIROS DE CAMIÑOS, CANAIS E PORTOS:	O ENXENHEIRO DE CAMIÑOS, CANAIS E PORTOS:	EXAMINADO A ENXENHEIRA XEFA:	DESBUXADO POR:	SUSTITUIRE A:	ESCALAS:	TÍTULO:	CLAVE:	NÚMERO DE PLANO:	DESIGNACIÓN DO PLANO:	DATA:
		AUTORES DO PROXECTO:	DIRECTOR DO PROXECTO:	CANALIZADO POR:	COMPROBADO POR:	SUSTITUIDO POR:	A1=1:500 A3=1:1.000	PROXECTO DE CONSTRUCCIÓN DE SENDA NA PQ-548 (PROQ 2+070 - 3+200) E CONTINUIDADE NUN VIAL MUNICIPAL NO CONCELLO DE VALS	PO/19/072.06	AN18.2	EXPROPIACIÓNS PLANTA XERAL SOBRE ORTOFOTO	DECEMBRO 2020	
		SANTIAGO J. PÉREZ VÁZQUEZ	IGNACIO TEIXEIRO GALVO	CARLOS LEFEBRE GALLÓN	MARÍA BÉGGES TEJADA LÓPEZ	LUCÍA GARCÍA MARTÍNEZ	SANTIAGO J. PÉREZ VÁZQUEZ				2 DE 3		NÚMERO DE FOLIA:

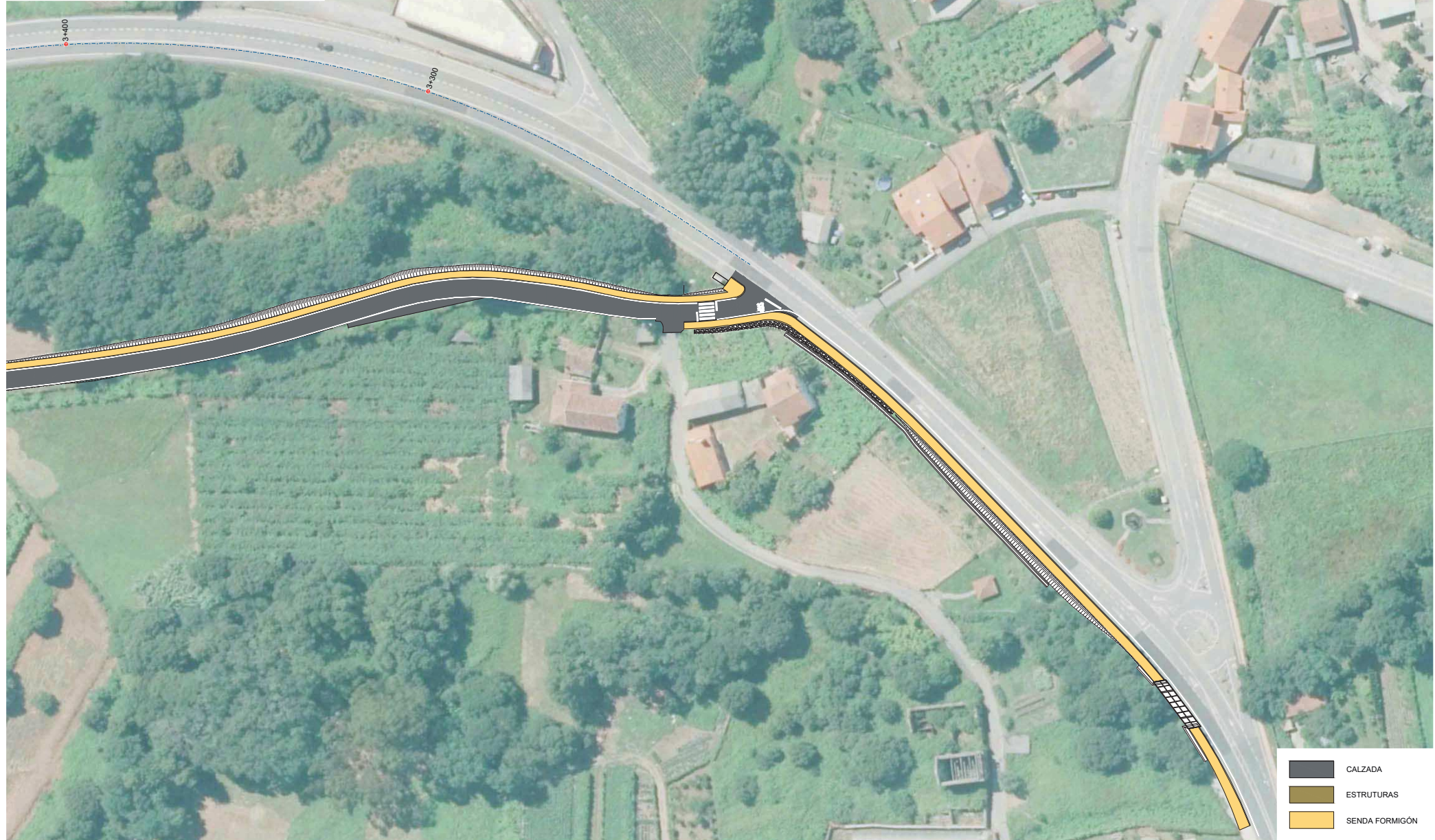
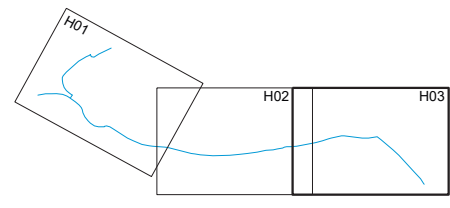

- CALZADA
- ESTRUTURAS
- SENDA FORMIGÓN

ESCALA: 1:1000. PROY. CONSTRUCCIÓN

XUNTA DE GALICIA CONSELLERÍA DE INFRAESTRUTURAS E MOBILIDADE	axi aviancia galega de infraestruturas	CONSULTOR: SNT SANTIAGO J. PÉREZ VÁZQUEZ IGNACIO TELLEIRO GALVO	O ENXENHEIRO DE CARBOL, CANLES E PORTOS DIRECTOR DO PROXECTO: SNT SANTIAGO J. PÉREZ VÁZQUEZ	EXAMINADO, A ENXENHEIRA XEFA: SNT MARIA XESUS TEJADA LÓPEZ	DESENHADO POR: LUCÍA GARCÍA MARTÍNEZ COMPROBADO POR: SANTIAGO J. PÉREZ VÁZQUEZ	SUBSTITUE A: _____ SUBSTITUÍDO POR: _____	ESCALAS: A1=1:500 A3=1:1.000 	TÍTULO: PROXECTO DE CONSTRUCCIÓN DE SENDA NA PG-548 (PROQ 2+670 - 3+200) E CONTINUIDADE NUN VIAL MUNICIPAL <small>NO CONCELLO DE VALDE</small>	CLAVE: PO/19/072.06	NÚMERO DE PLANO: AN18.2 FOLLA: 3 DE 3	DESIGNACIÓN DO PLANO: EXPROPIACIÓN PLANTA XERAL SOBRE ORTOFOTO	DATA: DECEMBRO 2020 NÚMERO DE PÁXINA: _____
--	---	--	---	--	---	--	--	--	------------------------	---	--	--

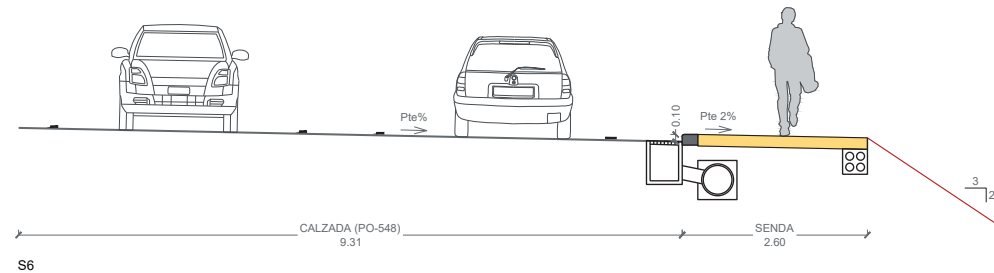
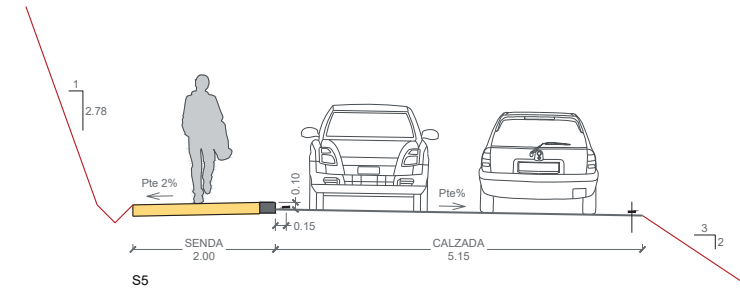
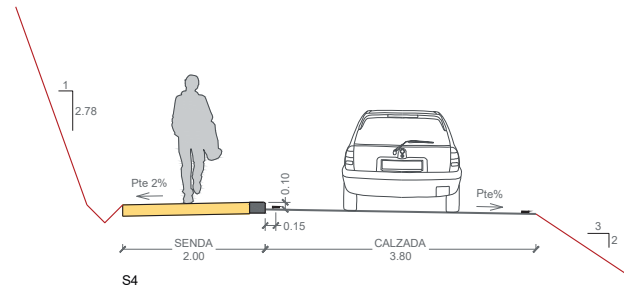
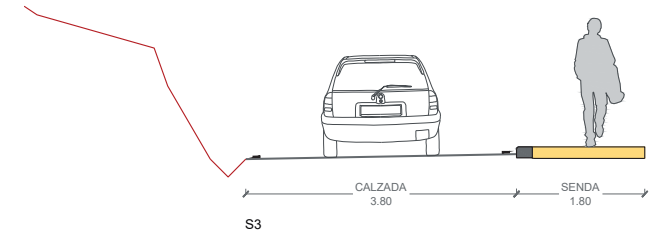
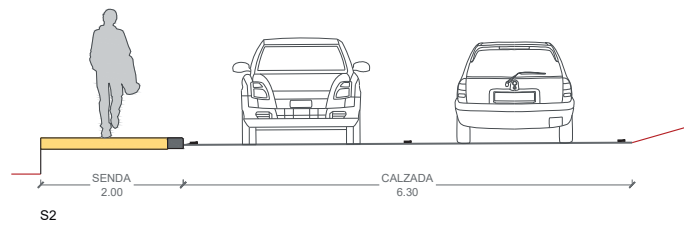
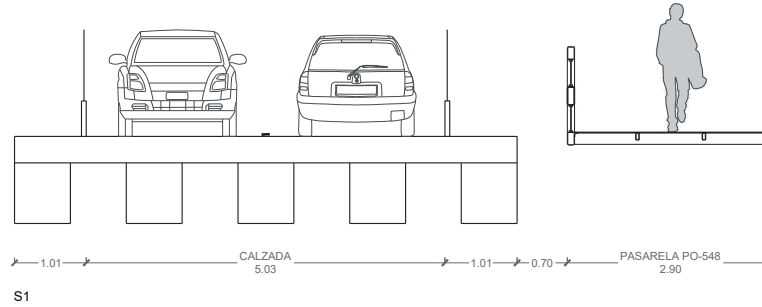
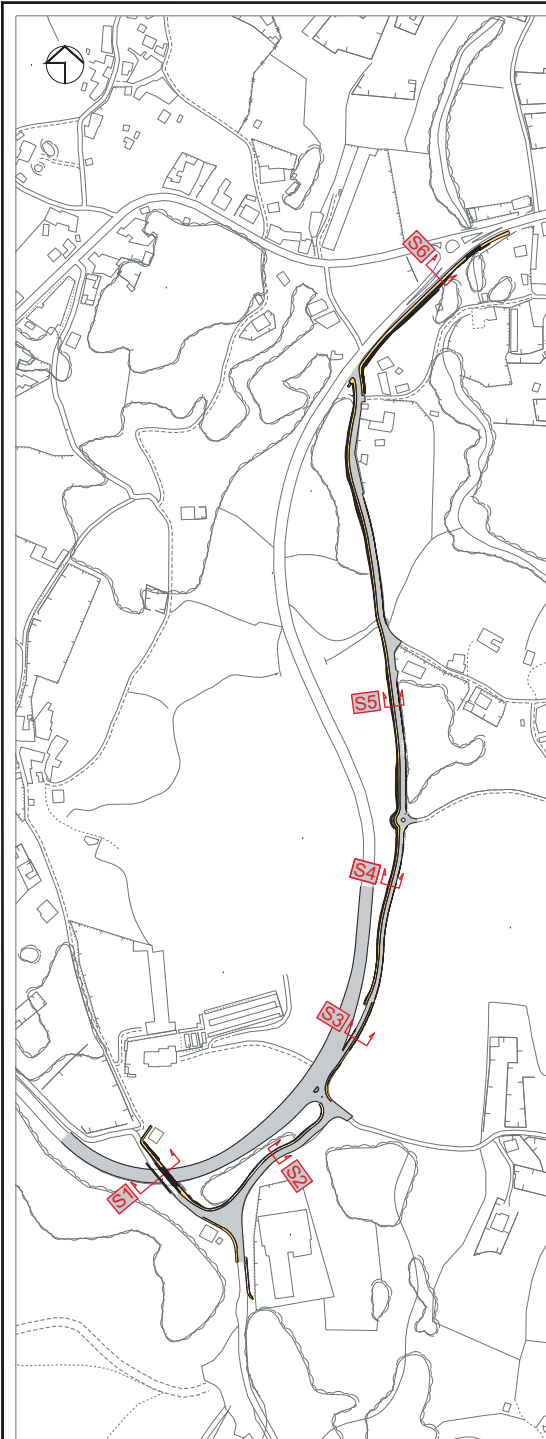

ESCALA: 1:100 - PROX. CONSTRUCCION

PUNTO	COORD, X	COORD, Y	PUNTO	COORD, X	COORD, Y	PUNTO	COORD, X	COORD, Y	PUNTO	COORD, X	COORD, Y	PUNTO	COORD, X	COORD, Y	PUNTO	COORD, X	COORD, Y	PUNTO	COORD, X	COORD, Y	PUNTO	COORD, X	COORD, Y
1	525847,0320	4726656,3870	33	525931,6846	4726601,4830	65	525940,5571	4726501,2728	97	526074,2456	4726870,3775	129	526075,9605	4726955,9883	161	526048,0058	4727192,4037	193	526047,4100	4727338,6300			
2	525848,4209	4726655,4067	34	525939,1407	4726612,3748	66	525939,4909	4726513,9673	98	526077,5036	4726883,1657	130	526075,2936	4726963,2863	162	526046,5160	4727202,2120	194	526047,4134	4727338,4305			
3	525840,2363	4726643,8099	35	525945,8205	4726620,2590	67	525938,1562	4726528,2715	99	526076,5378	4726883,4233	131	526074,9808	4726967,3111	163	526045,6804	4727206,7624	195	526042,7560	4727338,3535			
4	525840,3497	4726642,1558	36	525949,2184	4726623,8826	68	525937,8019	4726533,1491	100	526078,9881	4726892,6102	132	526074,8690	4726970,5635	164	526043,0189	4727216,5183	196	525935,3230	4726501,4255			
5	525841,0134	4726642,6921	37	525952,3596	4726626,8346	69	525936,6167	4726533,1550	101	526080,8414	4726900,5499	133	526075,0252	4726987,3284	165	526040,0552	4727225,8215	197	525937,7429	4726498,9339			
6	525843,1784	4726640,3652	38	525955,5743	4726629,5649	70	525934,6222	4726533,0069	102	526082,1940	4726908,5900	134	526075,2039	4726990,5478	166	526038,2863	4727231,4599	198	525938,5099	4726497,2548			
7	525845,9303	4726636,9423	39	525959,1203	4726632,2232	71	525932,1856	4726565,8382	103	526083,0280	4726915,5500	135	526076,1670	4726998,4084	167	526037,4363	4727234,5939	199	525939,5917	4726495,7592			
8	525855,0393	4726626,8042	40	525962,9785	4726634,7451	72	525932,0523	4726570,3933	104	526083,4980	4726921,9470	136	526076,1610	4727003,0303	168	526035,2012	4727245,2008	200	525940,9463	4726494,5053			
9	525856,3467	4726624,9051	41	525967,6166	4726637,3293	73	525932,3273	4726574,9421	105	526084,0610	4726930,6590	137	526075,6694	4727010,3413	169	526032,9674	4727253,6224	201	525942,5209	4726493,5419			
10	525854,4571	4726623,3794	42	525975,9950	4726641,1783	74	525933,0085	4726579,4480	106	526085,3210	4726934,2570	138	526075,2769	4727014,9665	170	526030,6235	4727259,6460	202	526033,0410	4726726,7574			
11	525855,2265	4726622,4272	43	525979,0738	4726643,0360	75	525934,0904	4726583,8748	107	526087,3700	4726937,0940	139	526074,3549	4727023,3542	171	526029,5634	4727263,0978	203	526033,7101	4726726,3113			
12	525852,6606	4726622,3621	44	525981,9421	4726645,1983	76	525935,5642	4726588,1870	108	526087,2672	4726937,2102	140	526072,1359	4727037,8688	172	526029,0300	4727266,2149	204	526038,1912	4726732,9596			
13	525851,5240	4726622,9299	45	525986,3193	4726649,3276	77	525937,4182	4726592,3499	109	526089,3737	4726938,6744	141	526070,3389	4727047,7313	173	526027,9465	4727280,9757	205	526039,5340	4726735,0096			
14	525870,8205	4726597,6045	46	525989,6651	4726652,3591	78	525939,6254	4726596,3106	110	526091,7620	4726939,6109	142	526067,7683	4727068,7739	174	526027,8712	4727284,5106	206	526041,4887	4726738,0987			
15	525871,5351	4726597,7752	47	525993,2679	4726655,2032	79	525942,2041	4726600,0956	111	526075,4000	4726925,5620	143	526066,5337	4727075,8828	175	526028,1251	4727288,4775	207	526043,3830	4726741,2464			
16	525874,7518	4726598,5857	48	526000,3998	4726660,4203	80	525941,1130	4726600,0665	112	526075,5772	4726928,9437	144	526066,1183	4727080,7919	176	526030,3936	4727305,5312	208	526045,5691	4726745,1767			
17	525879,9762	4726592,2564	49	526002,7577	4726662,6279	81	526029,5945	4726728,8075	113	526075,3630	4726930,6212	145	526066,0544	4727085,6214	177	526031,8941	4727313,1314	209	526048,1338	4726750,2767			
18	525880,7315	4726592,8822	50	526004,2967	4726665,0297	82	526031,3632	4726734,9476	114	526075,4041	4726933,0278	146	526065,3753	4727092,5346	178	526033,1519	4727319,0132	210	526050,2132	4726754,6917			
19	525883,2460	4726592,0328	51	526005,2842	4726667,8776	83	526038,7657	4726747,0298	115	526074,1304	4726933,2196	147	526061,2567	4727116,7775	179	526036,0651	4727332,1607	211	526052,8289	4726760,6570			
20	525884,3439	4726591,0759	52	526005,5277	4726670,7165	84	526044,1372	4726757,7408	116	526072,9415	4726934,5376	148	526059,9519	4727120,6143	180	526037,4109	4727332,1247	212	526055,0710	4726766,3446			
21	525887,4210	4726587,1801	53	526004,8227	4726673,4111	85	526048,7318	4726768,8074	117	526071,5518	4726936,4134	149	526058,6317	4727124,4849	181	526037,5785	4727335,7508	213	526056,6358	4726770,7470			
22	525890,3791	4726585,8507	54	526003,2392	4726675,6658	86	526045,5215	4726770,0080	118	526070,6891	4726938,0886	150	526057,5942	4727128,2959	182	526037,5868	4727339,3808	214	526056,7644	4726771,7549			
23	525894,6940	4726582,6440	55	526005,3002	4726677,2919	87	526047,9826	4726770,7524	119	526070,2304	4726939,3413	151	526057,0826	4727132,1512	183	526035,9816	4727339,4238	215	526058,9268	4726778,1153			
24	525898,3615	4726580,3536	56	526002,1966	4726679,0429	88	526052,3512	4726783,6362	120	526069,8843	4726940,9523	152	526056,5497	4727134,5509	184	526034,8448	4727346,8435	216	526059,6923	4726780,8914			
25	525900,0302	4726579,8394	57	525999,7205	4726678,7738	89	526052,6710	4726783,4910	121	526069,7914	4726942,6093	153	526056,1531	4727137,0626	185	526038,8052	4727349,8536	217	526060,5698	4726783,5832			
26	525902,0012	4726579,7037	58	525942,6734	4726493,8574	90	526054,5130	4726788,9836	122	526070,0227	4726944,3251	154	526055,4439	4727143,2126	186	526042,7605	4727353,0434	218	526061,3051	4726786,3687			
27	525904,5344	4726580,0547	59	525943,3913	4726495,3428	91	526055,8902	4726794,6107	123	526070,4811	4726945,5367	155	526054,4560	4727152,5359	187	526047,3524	4727356,9945	219	526061,8753	4726789,0379			
28	525911,1384	4726581,9113	60	525943,8216	4726496,3188	92	526056,6536	4726798,6682	124	526071,0789	4726946,6396	156	526053,5471	4727159,5352	188	526048,3557	4727349,2234						
29	525914,0434	4726583,2835	61	525942,9757	4726496,7387	93	526063,9522	4726829,9517	125	526071,7749	4726947,6048	157	526052,5912	4727165,4180	189	526048,6308	4727344,2962						
30	525916,8885	4726585,3638	62	525942,0031	4726497,6901	94	526064,4485	4726833,8409	126	526072,6211	4726948,6295	158	526051,8996	4727170,2555	190	526048,6454	4727341,2040						
31	525927,4042	4726596,4228	63	525941,2712	4726498,7857	95	526068,3352	4726845,0631	127	526075,0735	4726950,6941	159	526050,2882	4727180,2871	191	526046,4879	4727341,2040						
32	525931,1813	4726600,7666	64	525940,7848	4726499,9931	96	526070,3997	4726855,7270	128	526076,2185	4726953,7347	160	526049,2031	4727185,7530	192	526046,5372	4727339,4431						



ESCALA: 1:1000 CONSTRUCCIÓN

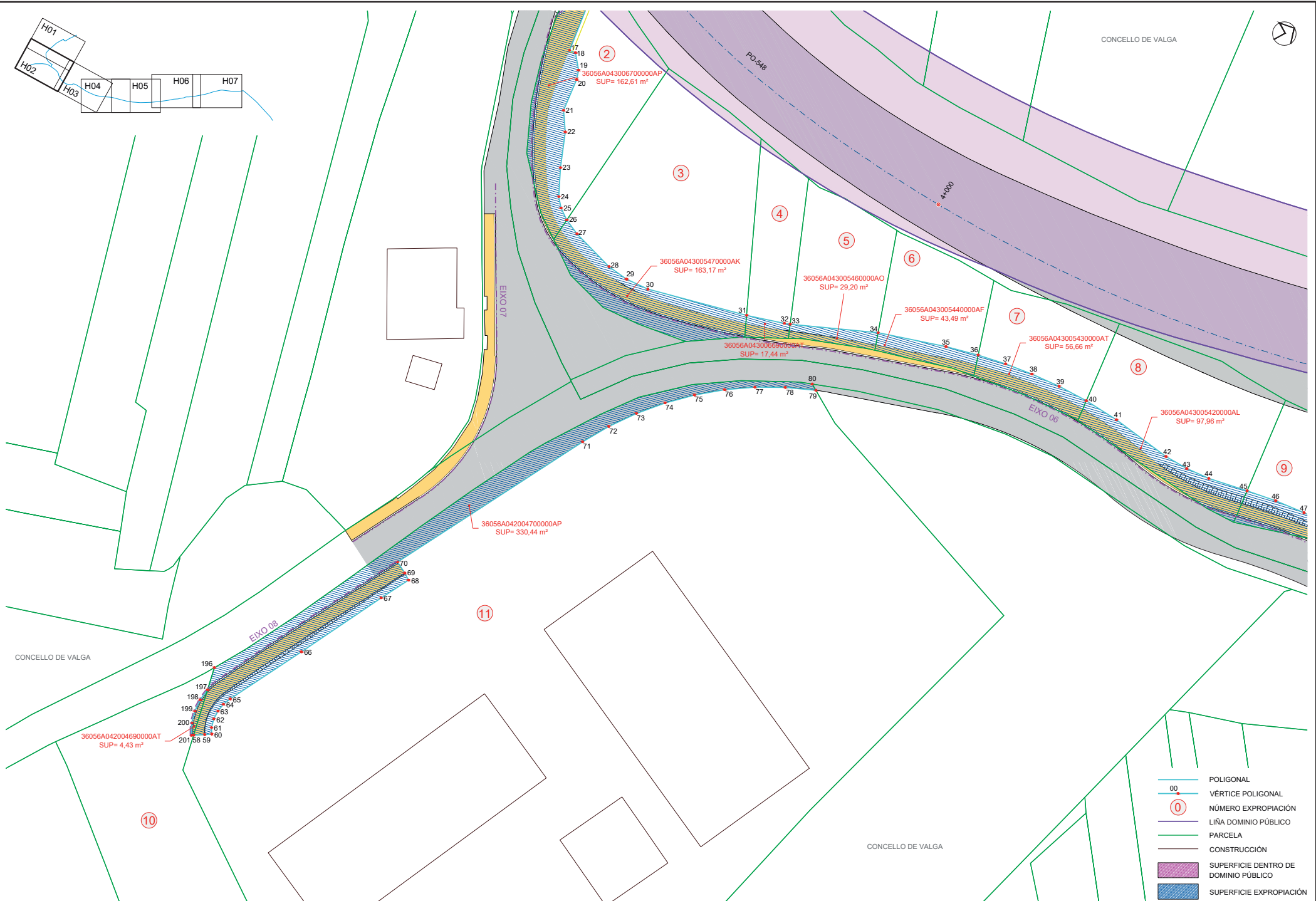
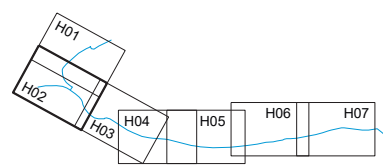

ESCALA: 1:500 CONSTRUCCIÓN

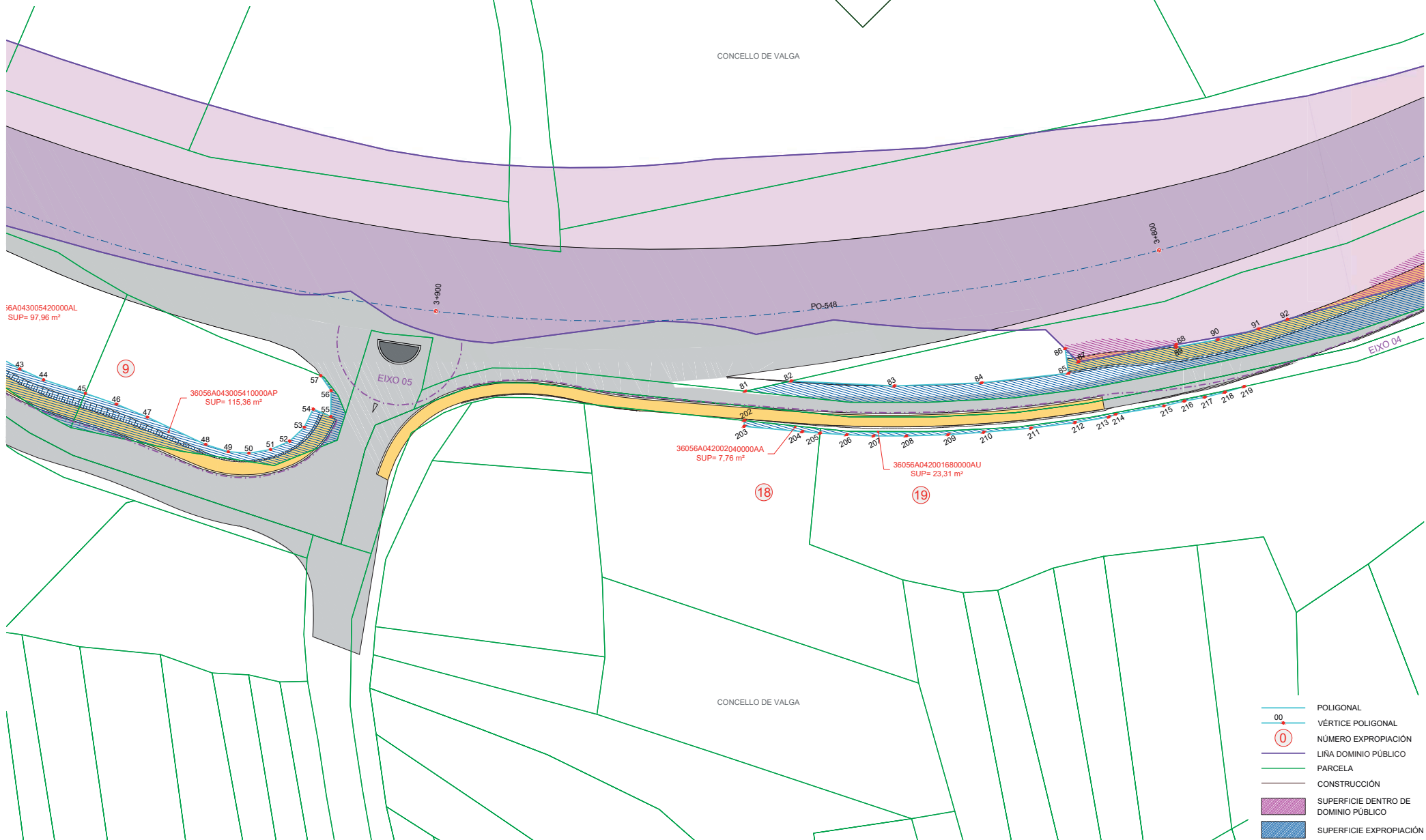
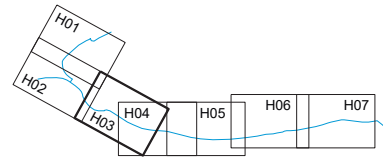

- POLIGONAL
- VÉRTICE POLIGONAL
- NÚMERO EXPROPIACIÓN
- LIÑA DOMINIO PÚBLICO
- PARCELA
- CONSTRUCCIÓN
- SUPERFICIE DENTRO DE DOMINIO PÚBLICO
- SUPERFICIE EXPROPIACIÓN

ESCALA: 1:500 CONSTRUCCIÓN

XUNTA DE GALICIA CONSELLERÍA DE INFRAESTRUTURAS E MOBILIDADE	avinca galega de infraestruturas	CONSULTOR:	OS ENXENHEIROS DE CAMIÑOS, CANAIS E PORTOS:	O ENXENHEIRO DE CAMIÑOS, CANAIS E PORTOS:	EXAMINADO A ENXENNERA XEPA:	DESBUXADO POR:	SUSTITUIU A:	ESCALAS:	TÍTULO:	CLAVE:	NÚMERO DE PLANO:	DESIGNACIÓN DO PLANO:	DATA:
		SANTIAGO J. PÉREZ VÁZQUEZ	IGNACIO TEJERO GALVO	CARLOS LEFEBRE GALLÓN	MARÍA XESÚS TEJADA LÓPEZ	LUCÍA GARCÍA MARTÍNEZ	SANTIAGO J. PÉREZ VÁZQUEZ	SANTIAGO J. PÉREZ VÁZQUEZ	SANTIAGO J. PÉREZ VÁZQUEZ	A1=1:250 A3=1:500	PROXECTO DE CONSTRUCCIÓN DE SENDA NA PO-548 (PROQ 2+070 - 3+200) E CONTINUIDADE NUN VIAL MUNICIPAL NO CONCELLO DE VALGA	PO/19/072.06	AN18.3 FOLLA: 4 DE 8



CONCELLO DE VALGA

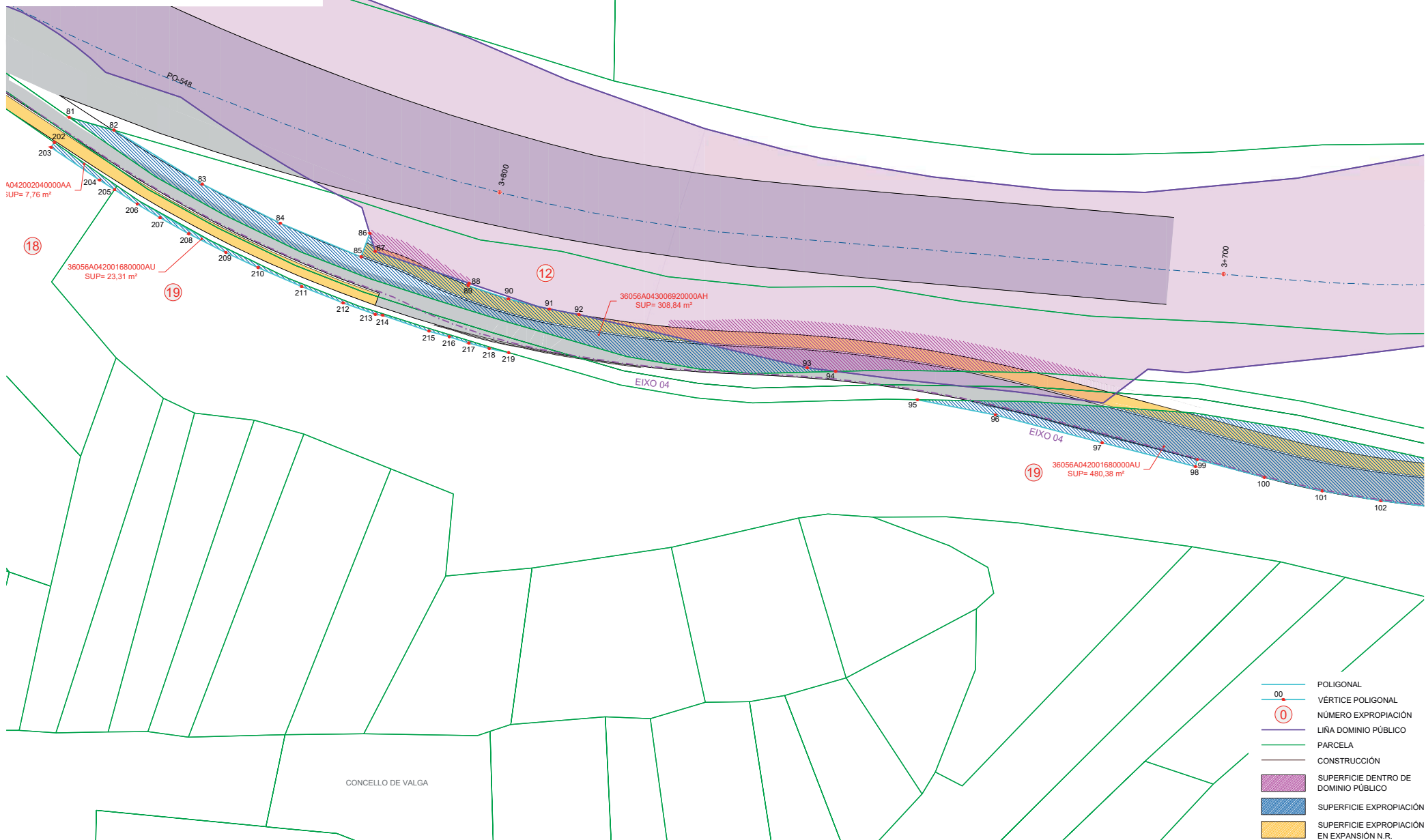
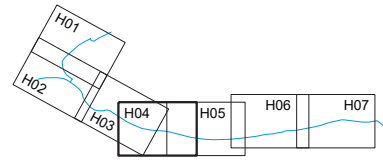

- POLIGONAL
- VÉRTICE POLIGONAL
- NÚMERO EXPROPIACIÓN
- LIÑA DOMINIO PÚBLICO
- PARCELA
- CONSTRUCCIÓN
- SUPERFICIE DENTRO DE DOMINIO PÚBLICO
- SUPERFICIE EXPROPIACIÓN
- SUPERFICIE EXPROPIACIÓN EN EXPANSIÓN N.R.

ESCALA: 1:1000 CONSTRUCCIÓN

XUNTA DE GALICIA CONSELLERÍA DE INFRAESTRUTURAS E MOBILIDADE	axia axia infraestruturas	CONSULTOR: SISEN	OS ENXENHEIROS DE CAMIÑOS, CANAIS E PORTOS: AUTORES DO PROXECTO: SANTIAGO J. PÉREZ VÁZQUEZ	O ENXENHEIRO DE CAMIÑOS, CANAIS E PORTOS: DIRECTOR DO PROXECTO: IGNACIO TEJERO GALVO	EXAMINADO A ENXENHEIRA XEFA: MARÍA JESÚS TEJADA LÓPEZ	DESENHADO POR: LUCÍA GARCÍA MARTÍNEZ	SUSTITUIRE A: _____	ESCALAS: A1=1:250 A3=1:500	TÍTULO: PROXECTO DE CONSTRUCCIÓN DE SENDA NA PO-548 (PROQ 2+670 - 3+200) E CONTRIBUÍDE NUN VAL MUNICIPAL	CLAVE: PO/19/072.06	NÚMERO DE PLANO: AN18.3	DESIGNACIÓN DO PLANO: EXPROPICIÁNS	DATA: DECEMBRO 2020
		SANTIAGO J. PÉREZ VÁZQUEZ	IGNACIO TEJERO GALVO	CARLOS LEFLER GALLÓN	SANTIAGO J. PÉREZ VÁZQUEZ	0 2,5 5 7,5 10	Nº DE CONCELLO DE VALGA	FOLLA: 5 DE 8	NÚMERO DE PÁXINA:				



CONCELLO DE VALGA

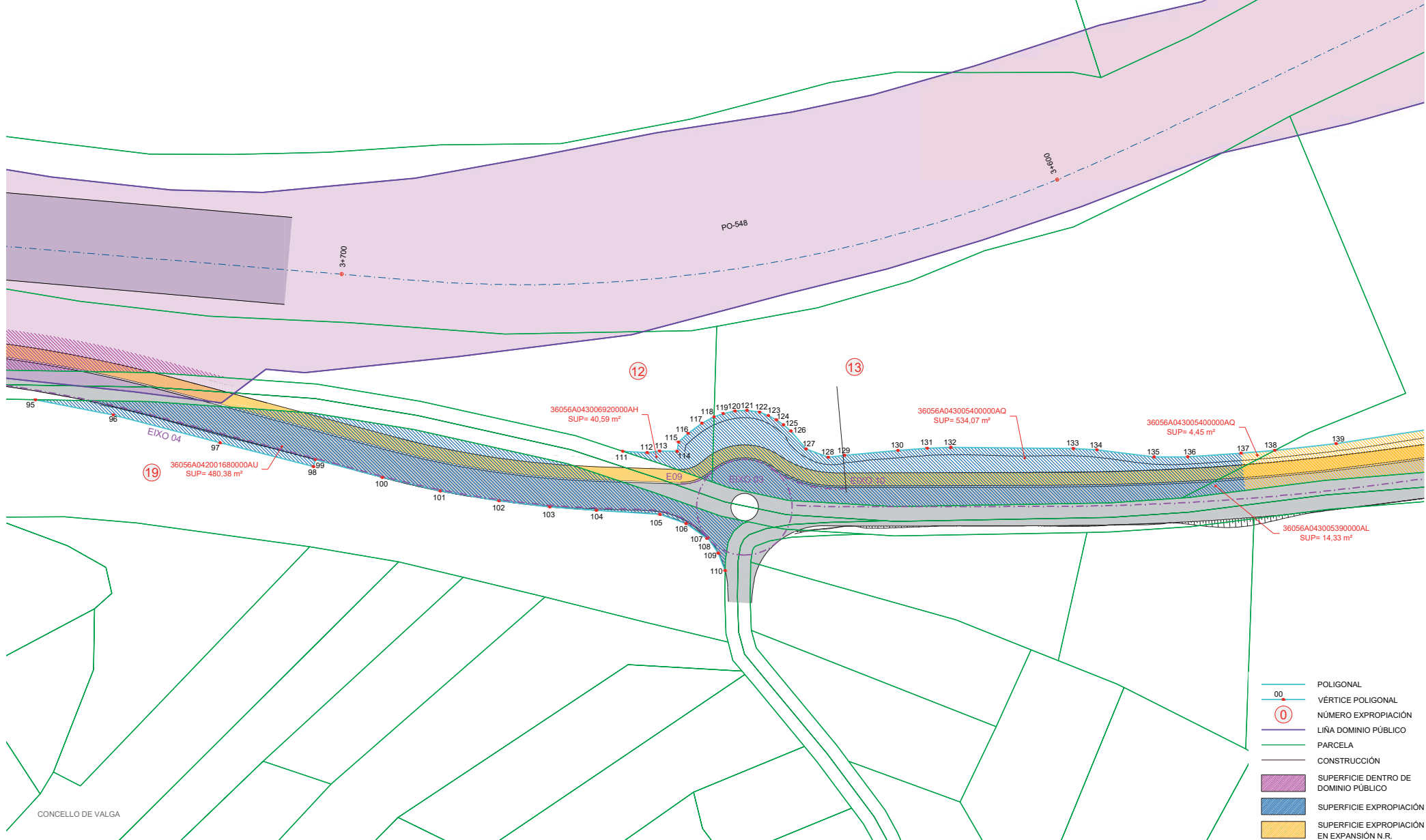

- POLIGONAL
- VÉRTICE POLIGONAL
- NÚMERO EXPROPIACIÓN
- LIÑA DOMINIO PÚBLICO
- PARCELA
- CONSTRUCCIÓN
- SUPERFICIE DENTRO DE DOMINIO PÚBLICO
- SUPERFICIE EXPROPIACIÓN
- SUPERFICIE EXPROPIACIÓN EN EXPANSIÓN N.R.

ESCALA: 1:1000 CONSTRUCCIÓN

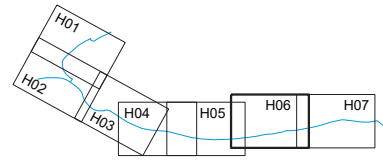
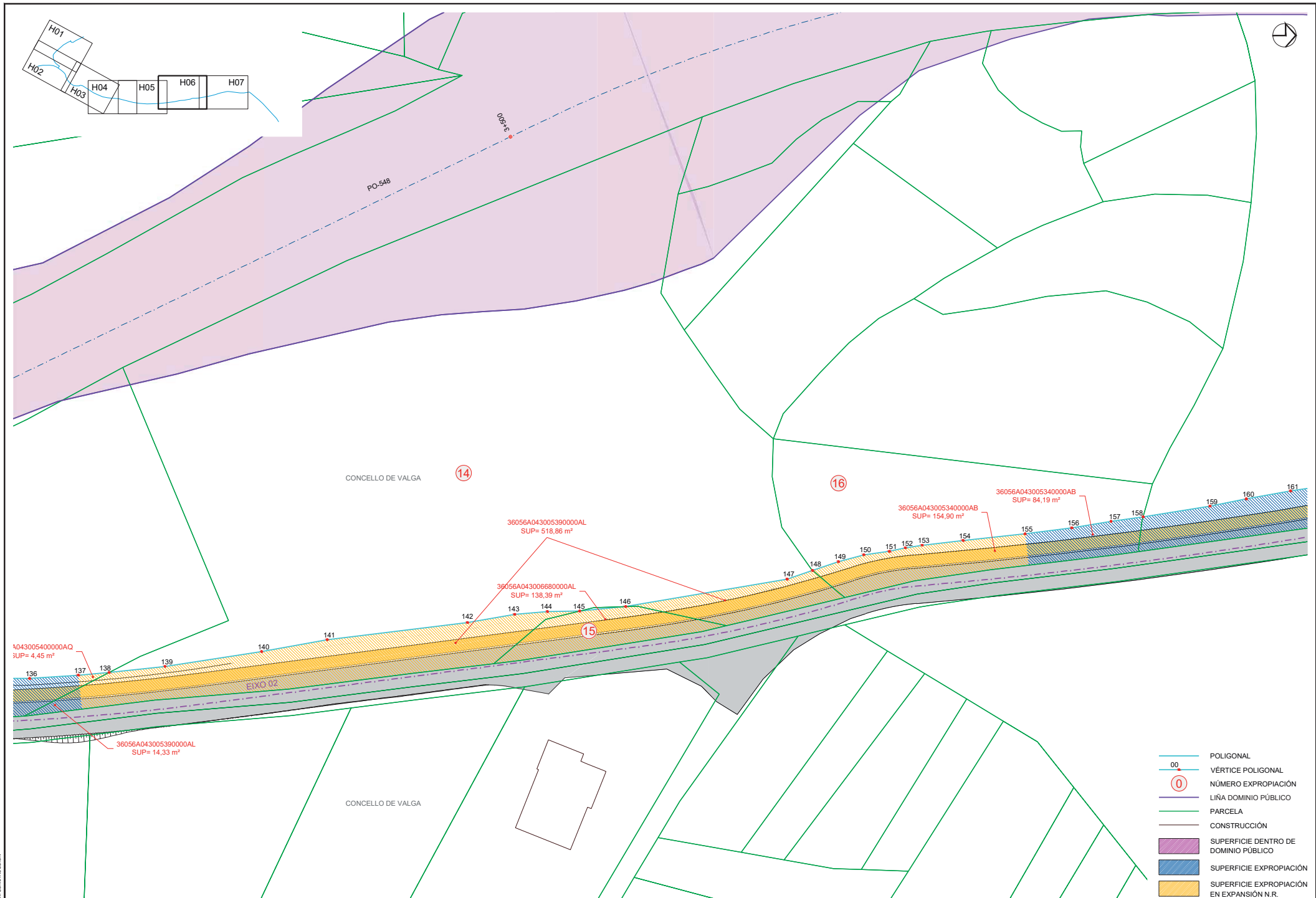

- POLIGONAL
- VÉRTICE POLIGONAL
- NÚMERO EXPROPIACIÓN
- LIÑA DOMINIO PÚBLICO
- PARCELA
- CONSTRUCCIÓN
- SUPERFICIE DENTRO DE DOMINIO PÚBLICO
- SUPERFICIE EXPROPIACIÓN
- SUPERFICIE EXPROPIACIÓN EN EXPANSIÓN N.R.

DESCRIPCIÓN DO PROXECTO: CONSTRUCCIÓN

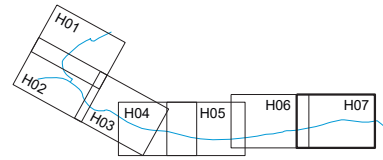
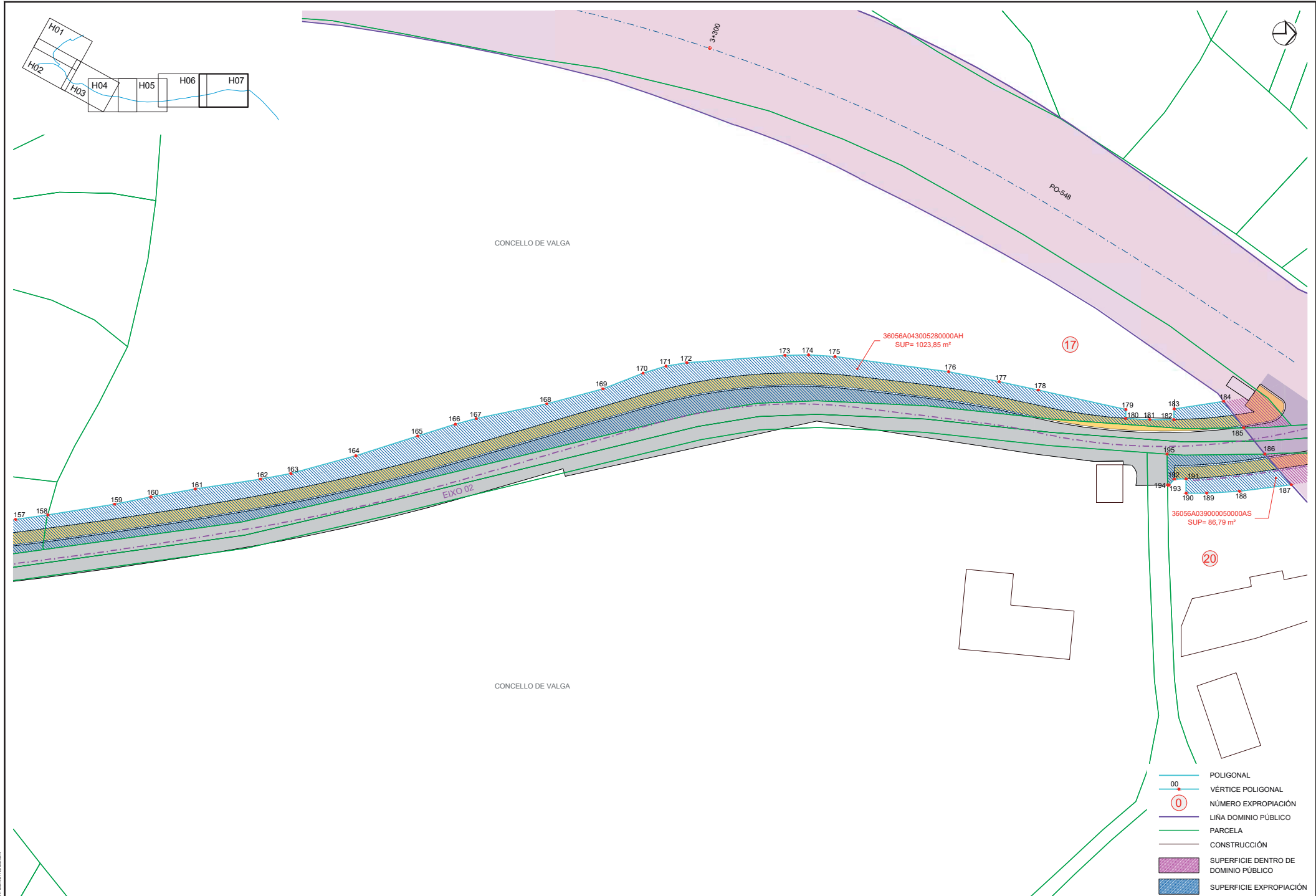

CONCELLO DE VALGA

CONCELLO DE VALGA

36056A04300528000AH
SUP= 1023,85 m²

36056A03900050000AS
SUP= 86,79 m²

- POLIGONAL
- VÉRTICE POLIGONAL
- NÚMERO EXPROPIACIÓN
- LIÑA DOMINIO PÚBLICO
- PARCELA
- CONSTRUCCIÓN
- SUPERFICIE DENTRO DE DOMINIO PÚBLICO
- SUPERFICIE EXPROPIACIÓN

ESCALA: 1:1000 CONSTRUCCIÓN

XUNTA DE GALICIA CONSELLERÍA DE INFRAESTRUTURAS E MOBILIDADE		CONSULTOR	OS ENXENHEIROS DE CAMIÑOS, CANLES E PORTOS	O ENXENHEIRO DE CAMIÑOS, CANLES E PORTOS	EXAMINADO/A ENXENHEIRA XEFA	DESBUXADO POR:	SUSTITUIU A:	ESCALAS	TÍTULO	CLAVE	NÚMERO DE PLANO	DESIGNACIÓN DO PLANO	DATA
		SANTIAGO J. PÉREZ VÁZQUEZ	IGNACIO TEJERO GALVO	CARLOS LEFLER GALLÓN	MARÍA XESÚS TEJADA LÓPEZ	LUCÍA GARCÍA MARTÍNEZ	MARÍA XESÚS TEJADA LÓPEZ	SANTIAGO J. PÉREZ VÁZQUEZ		A1=1:250 A3=1:500 	PROXECTO DE CONSTRUCCIÓN DE SENDA NA PO-548 (PROQ 2+670 - 3+200) E CONTINUIDADE NUN VIAL MUNICIPAL <small>NO CONCELLO DE VALGA</small>	PO/19/072.06	AN18.3